













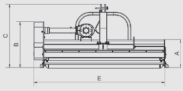

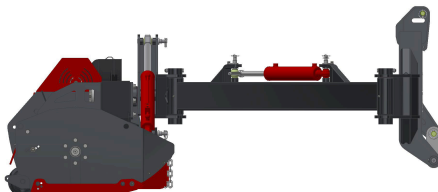
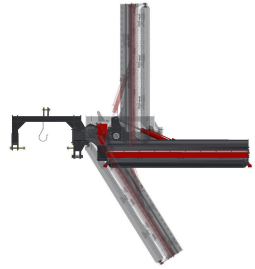

Fischer Flail-Mower L2 + HS Range

S-MOWER L2 HL	S-MOWER L2 FL	S-MOWER L2 FHL
		
Rear Mountable With Hydraulic Side-Shift Left/Right	Front Mountable with Hydraulic Side-Shift Left/Right	Front and Rear Mountable with Hydraulic Side-Shift Left/Right

L2	 SCHLÄGEL MAZZE HAMMER	 HP	 KG	 Arbeitsbreite Larghezza di lavoro Working width		 A	 B	 C	 D
Mod.									
S-MOWER-L2 185	16	50-100	780	179	3+3	186	41	103	90
S-MOWER-L2 235	20	60-100	840	229	3+3	236	41	103	90
S-MOWER-L2 285	24	70-120	910	279	3+3	286	41	103	90

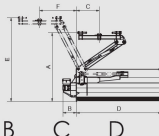
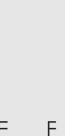
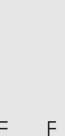
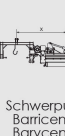
S-MOWER HS	S-MOWER HS (side view)	S-MOWER HS (tolerance)
		

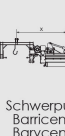
HS	 SCHLÄGEL MAZZE HAMMER	 HP	 KG	 Arbeitsbreite Larghezza di lavoro Working width		Neigung Inclinazione Inclination	 A	 B	 C	 D	 E	 F	Schwerpunkt X Barricentro X Barycenter X
Mod.													
S-MOWER-H-S 175	14	70-120	920	170	5	-60° / +90°	205	40	67	175	245	110	140
S-MOWER-H-S 200	16	80-120	960	195	5	-60° / +90°	205	40	67	200	245	110	147
S-MOWER-H-S 225	18	90-120	1010	220	5	-60° / +90°	205	40	67	225	245	110	155
S-MOWER-H-S 250	20	90-120	1050	145	5	-60° / +90°	205	40	67	250	245	110	162